



AU**STREAM**<sup>TM</sup>

## Kitchen Ventilation Systems

DESIGNED FOR VALUE,  
ENGINEERED FOR  
PERFORMANCE.

**FSM**

MELBOURNE | SYDNEY | BRISBANE | PERTH



FSM has over 10 years experience with low velocity canopies, being an early innovator into Australia.

Australian owned. Excellence since 1976



**FSM**

AU**S**TREAM™

## Designed for value, engineered for performance...

FSM has been trading in Australia since 1976 and has established a national reputation for providing high quality food service equipment to all sectors of the industry. We continue to innovate and lead the way in trends, with the Austream kitchen ventilation system being a new solution available to provide our customers with long term solutions that improve their productivity and the bottom line.

The FSM head office and manufacturing site is in Melbourne with additional offices in Sydney, Brisbane and Perth – which is the second manufacturing site for Austream, to ensure that we have our customers covered from the east to the west coast of Australia for timely deliveries.

Our Sales Team have catering industry backgrounds in various forms, and over 10 years experience with kitchen ventilation systems in Australia. Terry Randall, the Managing Director for over twenty-five years, has a comprehensive knowledge of the food service industry, gained during his almost 40-year association with FSM. This is a knowledgeable team that you can trust for prompt, efficient and quality service.

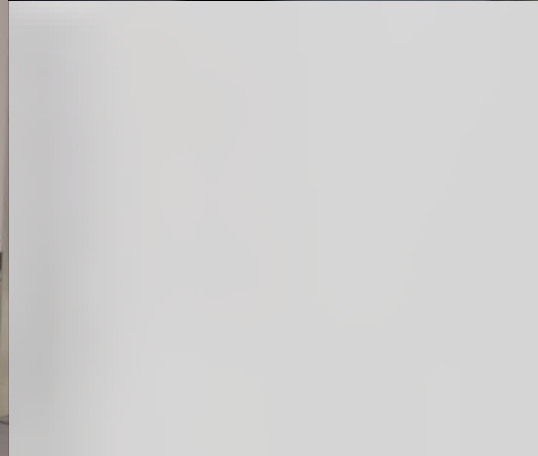
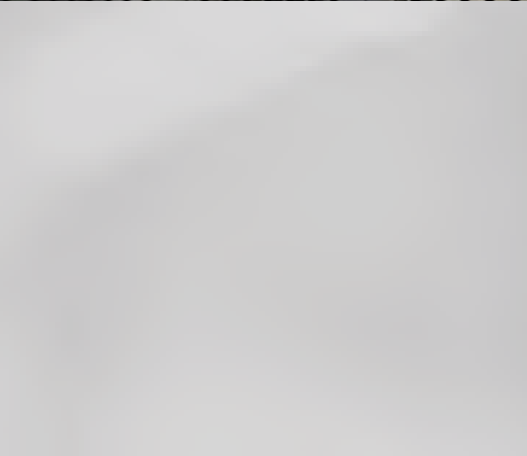



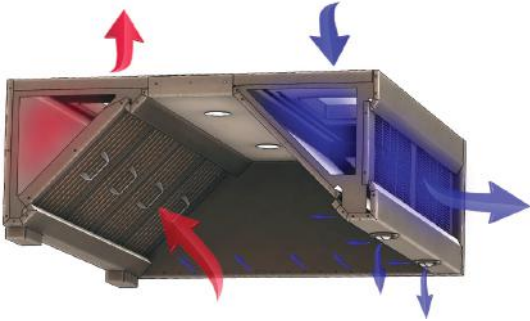

**I SERIES**  
Inspire with supply air

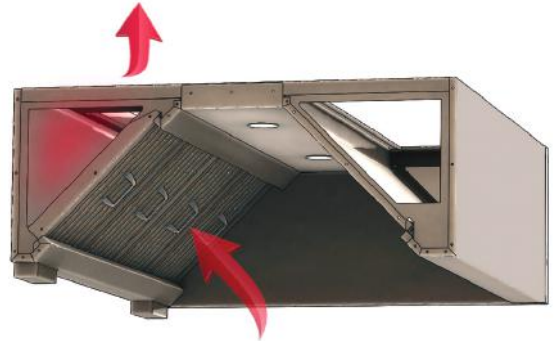

**EO SERIES**  
Extract only

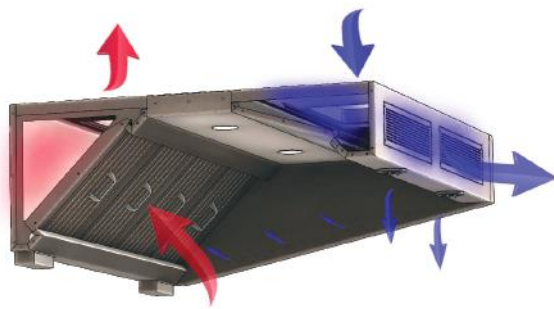

**IR SERIES**  
Inspire with reduced front and supply air

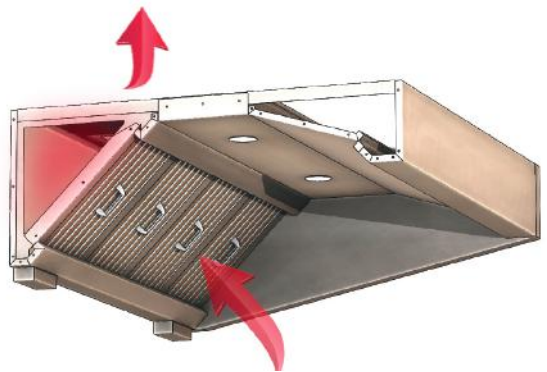

**EOR SERIES**  
Extract only reduced front

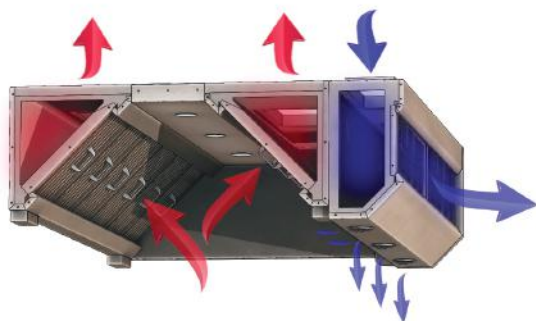

**IEFB SERIES**  
Inspire with dual extract and supply air

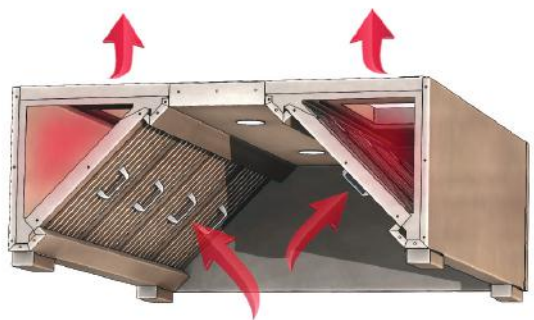

**EOFB SERIES**  
Extract only front & back

| Standard Lengths | Number of LED Lights | Size of Extract Spigots (mm)     | Size of Supply Spigots (mm)      | Weight (kg) |
|------------------|----------------------|----------------------------------|----------------------------------|-------------|
| 1200             | 2                    | (1x) 350 x 300                   | (1x) 350 x 300                   | 85          |
| 1350             | 2                    | (1x) 350 x 300                   | (1x) 350 x 300                   | 95          |
| 1550             | 2                    | (1x) 450 x 300                   | (1x) 450 x 300                   | 110         |
| 1700             | 2                    | (1x) 450 x 300                   | (1x) 450 x 300                   | 120         |
| 1900             | 3                    | (1x) 550 x 300                   | (1x) 550 x 300                   | 125         |
| 2050             | 3                    | (1x) 550 x 300                   | (1x) 550 x 300                   | 130         |
| 2250             | 3                    | (1x) 550 x 300                   | (1x) 550 x 300                   | 135         |
| 2400             | 3                    | (1x) 550 x 300                   | (1x) 550 x 300                   | 150         |
| 2650             | 4                    | (1x) 350 x 300<br>(1x) 450 x 300 | (1x) 350 x 300<br>(1x) 450 x 300 | 175         |
| 2800             | 4                    | (1x) 350 x 300<br>(1x) 450 x 300 | (1x) 350 x 300<br>(1x) 450 x 300 | 185         |
| 3000             | 4                    | (2x) 450 x 300                   | (2x) 450 x 300                   | 190         |
| 3150             | 4                    | (2x) 450 x 300                   | (2x) 450 x 300                   | 200         |
| 3350             | 5                    | (1x) 450 x 300<br>(1x) 550 x 300 | (1x) 450 x 300<br>(1x) 550 x 300 | 210         |
| 3500             | 5                    | (1x) 450 x 300<br>(1x) 550 x 300 | (1x) 450 x 300<br>(1x) 550 x 300 | 220         |
| 3700             | 6                    | (2x) 550 x 300                   | (2x) 550 x 300                   | 225         |
| 3850             | 6                    | (2x) 550 x 300                   | (2x) 550 x 300                   | 230         |
| 4050             | 6                    | (2x) 550 x 300                   | (2x) 550 x 300                   | 235         |
| 4200             | 6                    | (2x) 550 x 300                   | (2x) 550 x 300                   | 240         |
| 4400             | 6                    | (2x) 550 x 300                   | (2x) 550 x 300                   | 260         |
| 4550             | 6                    | (2x) 550 x 300                   | (2x) 550 x 300                   | 265         |
| 4800             | 7                    | (2x) 450 x 300<br>(1x) 550 x 300 | (2x) 450 x 300<br>(1x) 550 x 300 | 290         |
| 4950             | 7                    | (2x) 450 x 300<br>(1x) 550 x 300 | (2x) 450 x 300<br>(1x) 550 x 300 | 310         |
| 5150             | 8                    | (1x) 450 x 300<br>(2x) 550 x 300 | (1x) 450 x 300<br>(2x) 550 x 300 | 315         |
| 5300             | 8                    | (1x) 450 x 300<br>(2x) 550 x 300 | (1x) 450 x 300<br>(2x) 550 x 300 | 330         |
| 5500             | 9                    | (3x) 550 x 300                   | (3x) 550 x 300                   | 335         |
| 5650             | 9                    | (3x) 550 x 300                   | (3x) 550 x 300                   | 345         |
| 5850             | 9                    | (3x) 550 x 300                   | (3x) 550 x 300                   | 350         |
| 6000             | 9                    | (3x) 550 x 300                   | (3x) 550 x 300                   | 360         |
| 6200             | 9                    | (3x) 550 x 300                   | (3x) 550 x 300                   | 365         |
| 6350             | 9                    | (3x) 550 x 300                   | (3x) 550 x 300                   | 370         |
| 6550             | 9                    | (3x) 550 x 300                   | (3x) 550 x 300                   | 375         |
| 6700             | 9                    | (3x) 550 x 300                   | (3x) 550 x 300                   | 385         |

Standard depths 1300 and 1650. Standard sizes are available in a faster time frame and are more cost effective.  
Custom sizes available on request

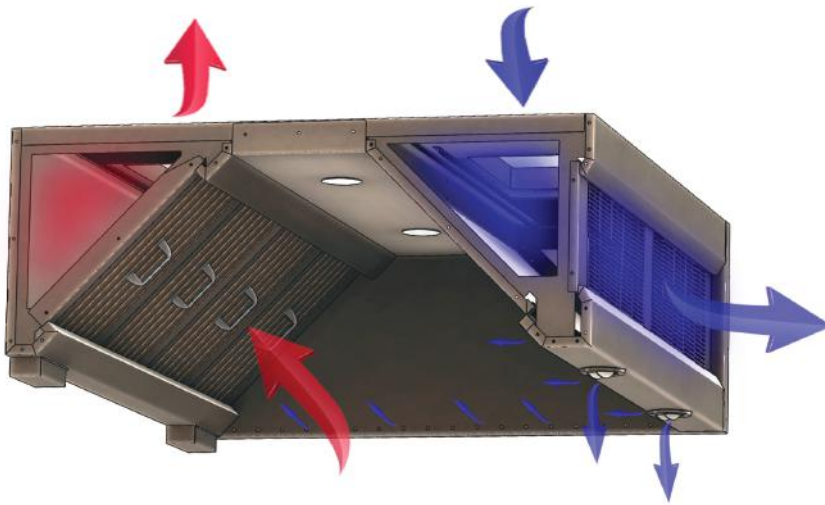

- 30-50% reduction of air flow rates (versus conventional hoods)
- Stainless steel chefs' coolers
- LED downlights achieving 500 lux at working surface
- External grease management system with grease drawer "full" indicator
- Austream induction technology
- Stainless steel grease separators
- Full stainless-steel construction and easy to clean design
- Lightweight monocoque chassis for structural integrity
- Sliding plate dampers on extract and supply spigots
- Condensation channel

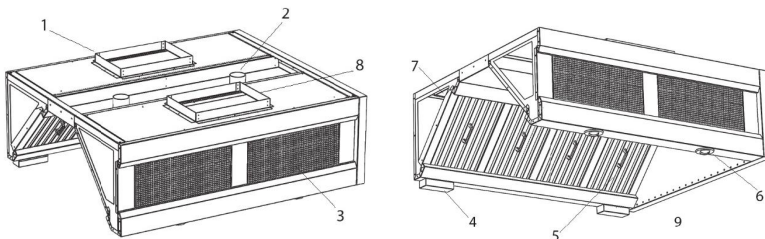

1. Exhaust Connection
2. LED Lighting
3. Perforated Make Up Air Panel
4. Grease Drawer
5. Grease Separator
6. Cooling Nozzle
7. Sliding Plate Damper
8. Return Air Connection
9. HoodMaster Induction Technology

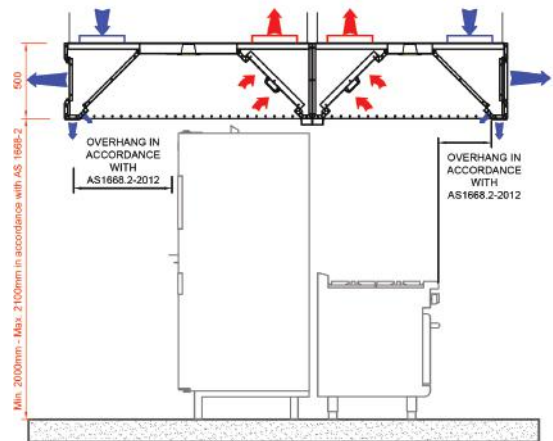
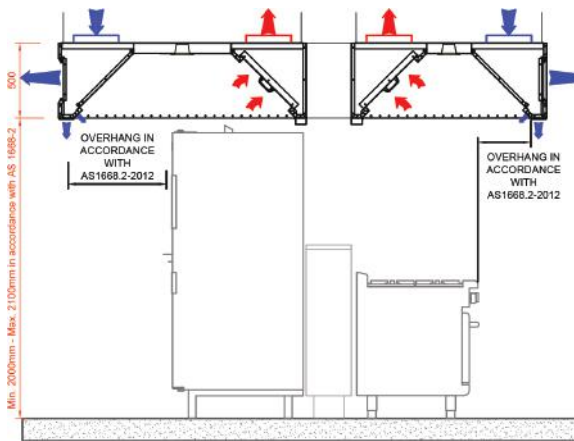
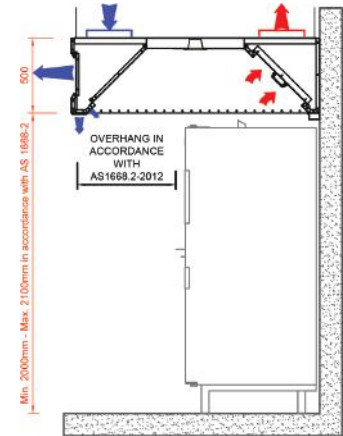
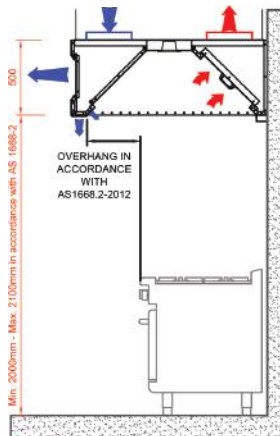

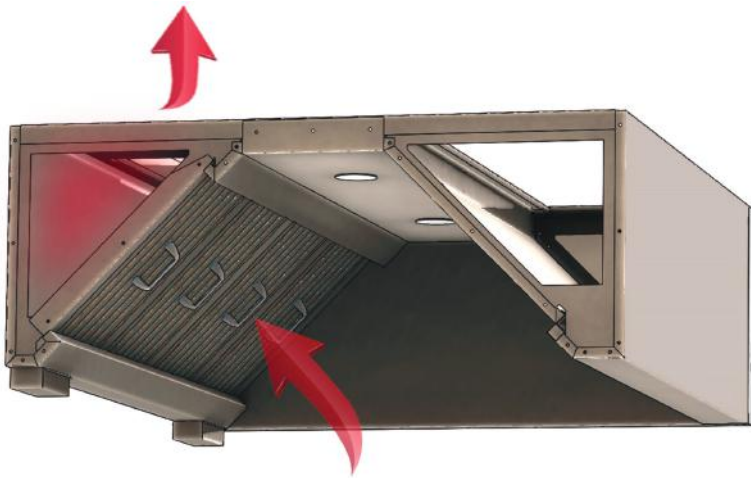

- 30-50% reduction of air flow rates (versus conventional hoods)
- External grease management system with grease drawer “full” indicator
- LED downlights achieving 500 lux at working surface
- Stainless steel grease separators
- Full stainless-steel construction and easy to clean design
- Lightweight monocoque chassis for structural integrity
- Sliding plate dampers
- Condensation channel

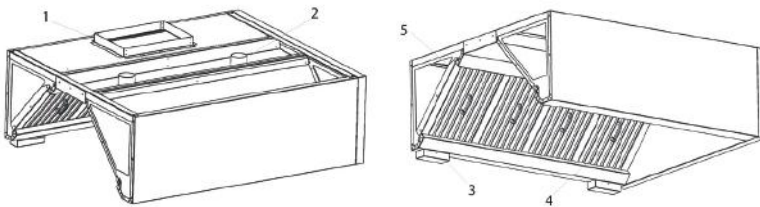

1. Exhaust Connection
2. LED Lighting
3. Grease Drawer
4. Grease Separator
5. Sliding Plate Damper

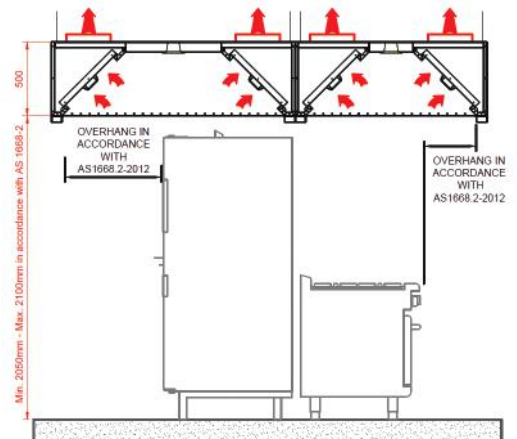
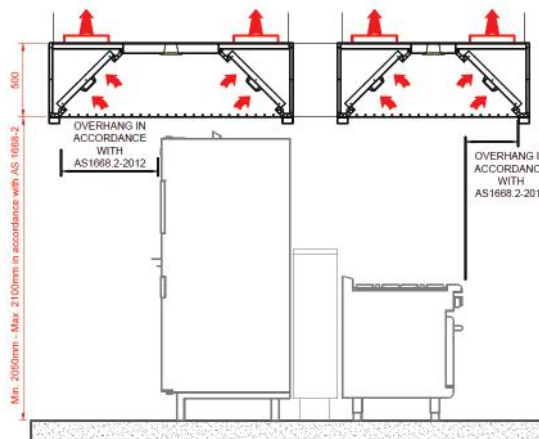
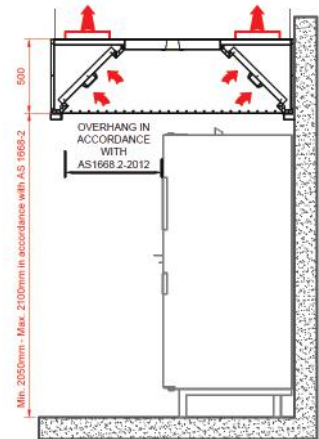
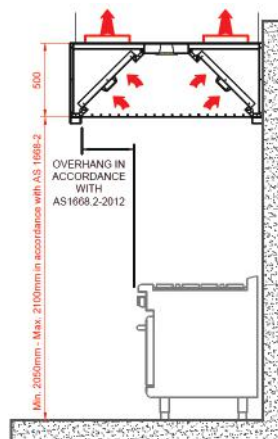



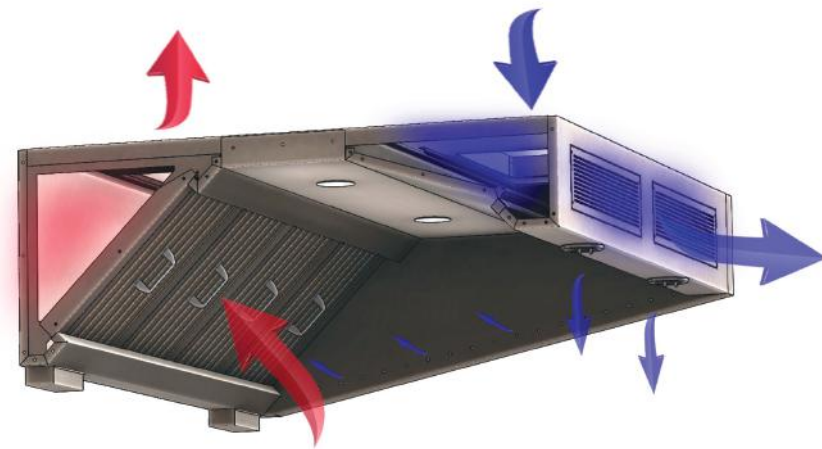

- Reduced height design can go into 2250mm High Ceilings
- Stainless steel chefs' coolers
- Austream induction technology
- Stainless-steel grease separators
- Full stainless-steel construction and easy to clean design
- Lightweight monocoque chassis for structural integrity
- LED downlights achieving 500 lux at working surface
- Sliding plate dampers on extract and supply spigots
- Condensation channel

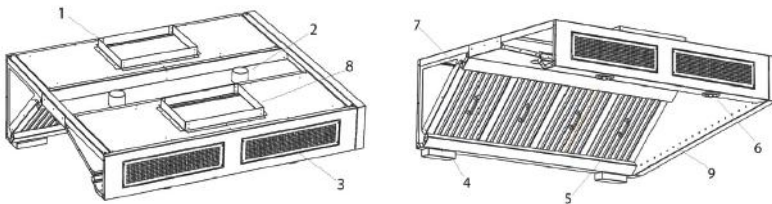

1. Exhaust Connection
2. LED Lighting
3. Perforated Make Up Air Panel
4. Grease Drawer
5. Grease Separator
6. Cooling Nozzle
7. Sliding Plate Damper
8. Return Air Connection
9. HoodMaster Induction Technology

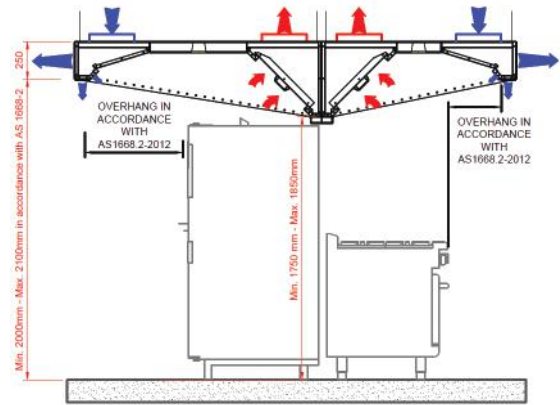
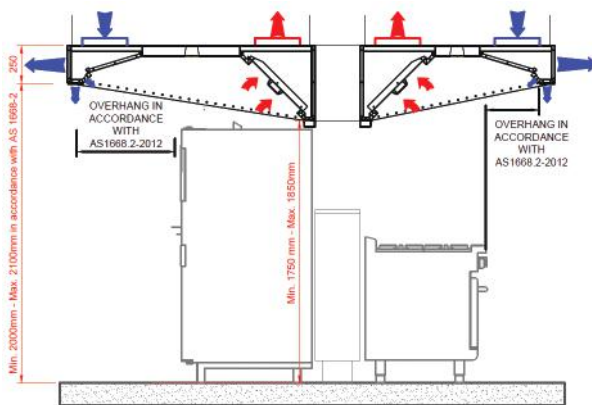
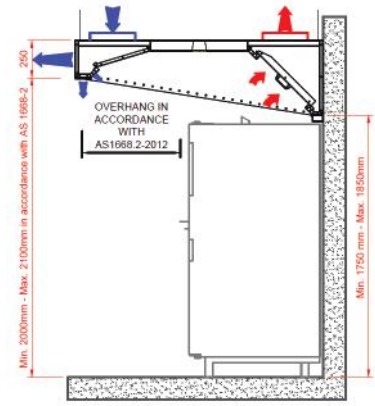
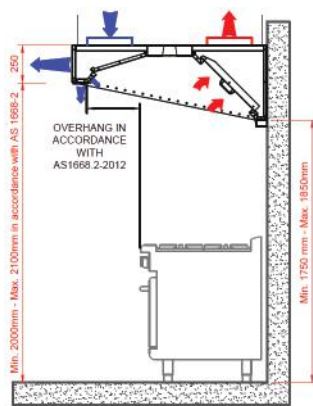



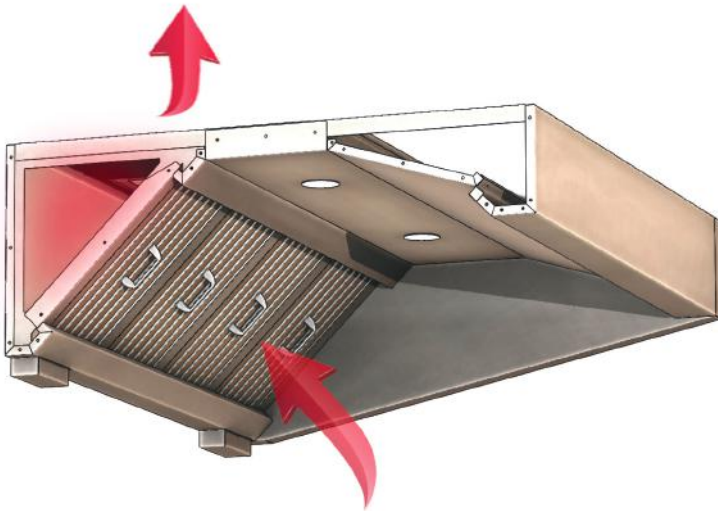

- Reduced height design, can be installed with a 2250mm ceiling height
- Grease management system with grease drawer “full” indicator
- Stainless steel grease separators
- Full stainless-steel construction and easy to clean design
- Lightweight monocoque chassis for structural integrity
- LED downlights achieving 500 lux at working surface
- Sliding plate dampers
- Condensation channel

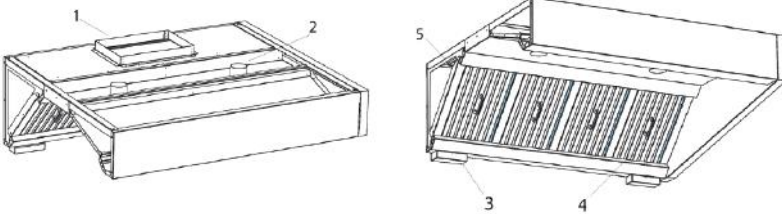

1. Exhaust Connection
2. LED Lighting
3. Grease Drawer
4. Grease Separator
5. Sliding Plate Damper

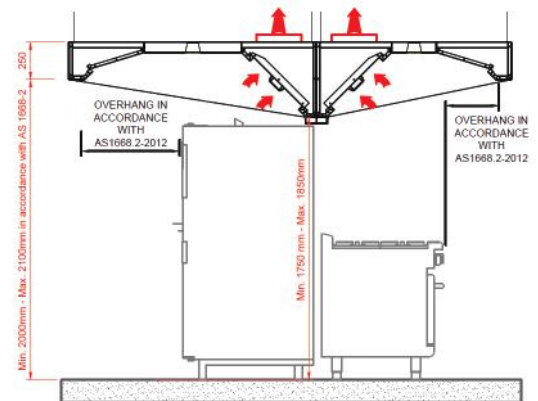
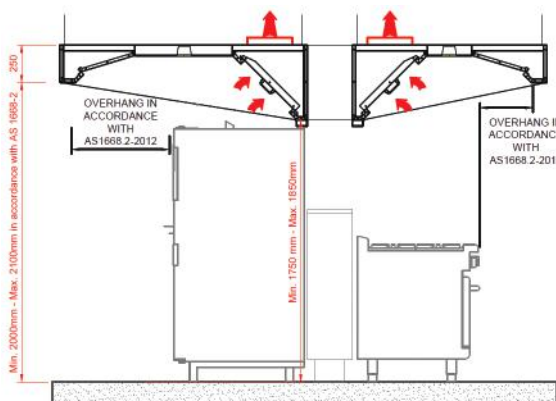
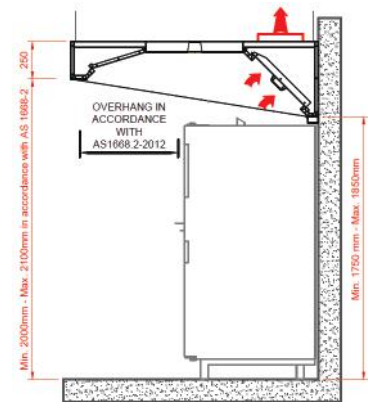
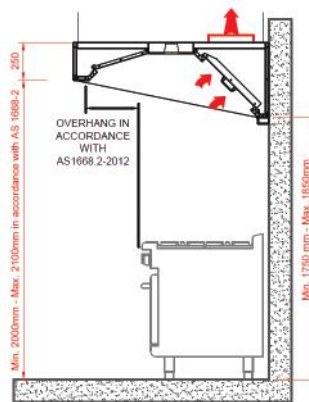

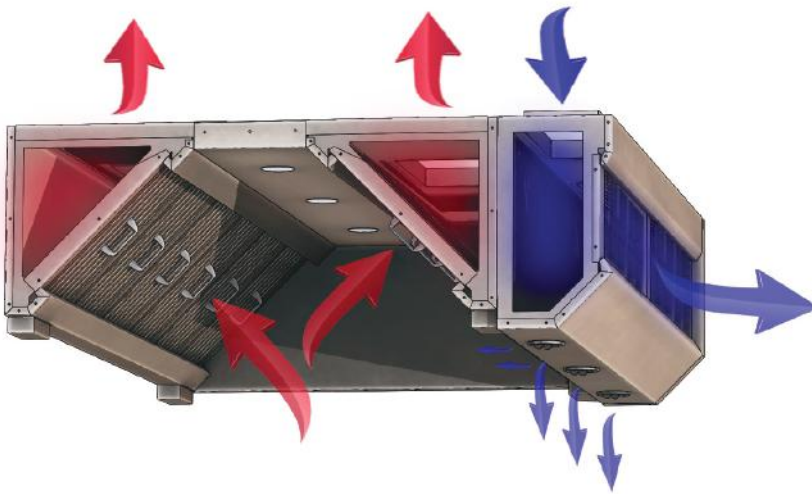

- Peripheral filter placement ensures the most efficient method of capture and containment of acrid fumes
- External grease management system with grease drawer “full” indicator
- Ideal for solid fuel and Asian style cooking (heavy duty)
- Stainless-steel grease separators
- Lightweight monocoque chassis for structural integrity
- LED downlights achieving 500 lux at working surface
- Sliding plate dampers on extract and supply spigots
- Stainless steel chefs’ coolers
- Austream induction technology

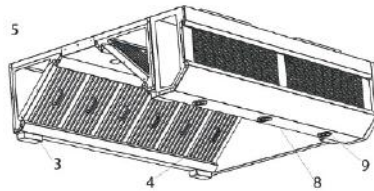
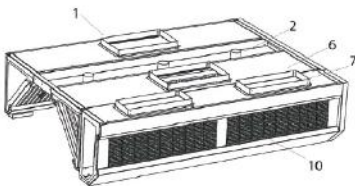

1. Exhaust Connection
2. LED Lighting
3. Grease Drawer
4. Grease Separator
5. Sliding Plate Damper
6. Exhaust Connection
7. Return Air Connection
8. HoodMaster Induction Technology
9. Cooling Nozzle
10. Perforated Make Up Air Panel

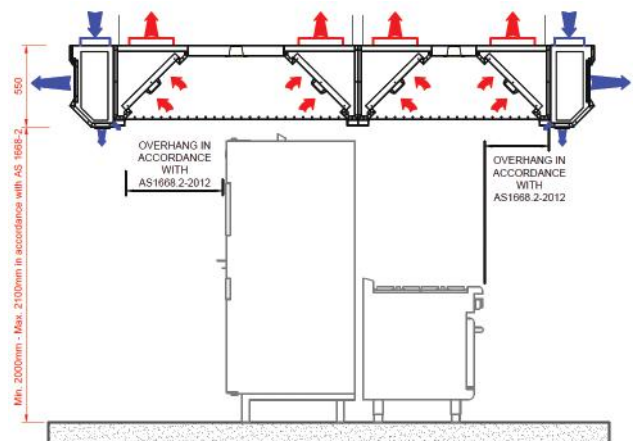
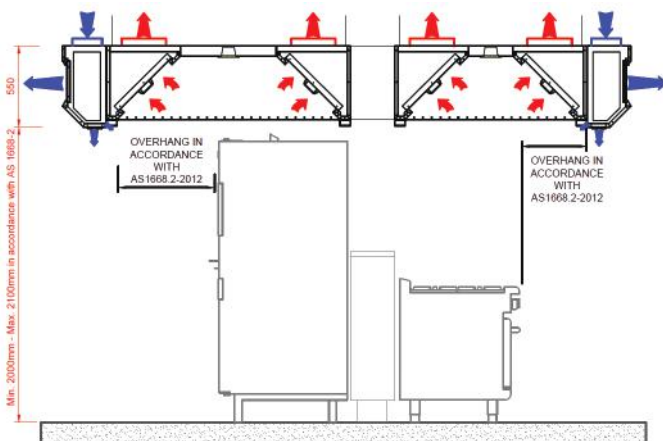
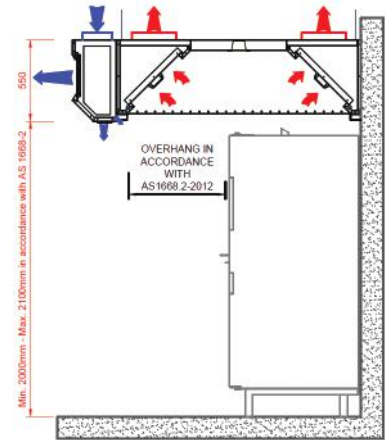
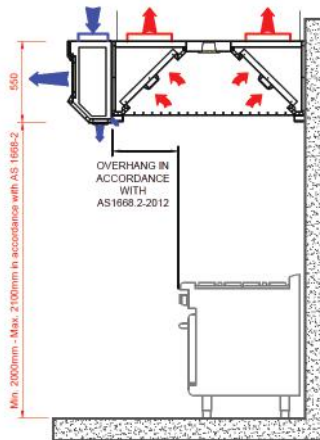

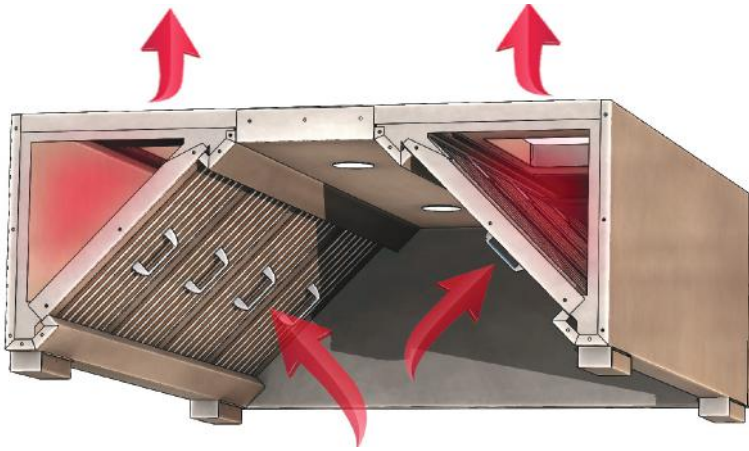

- Peripheral filter placement ensures the most efficient method of capture and containment of acrid fumes
- External grease management system with grease drawer “full” indicator
- Ideal for solid fuel and Asian style cooking (heavy duty)
- Stainless-steel grease separators (front and back)
- Lightweight monocoque chassis for structural integrity
- LED downlights achieving 500 lux at working surface
- Sliding plate dampers

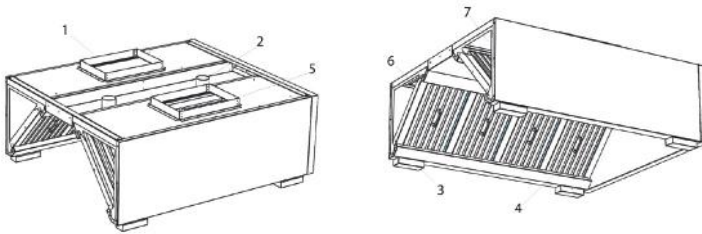

1. Exhaust Connection
2. LED Lighting
3. Grease Drawer
4. Grease Separator
5. Exhaust Connection
6. Sliding Plate Damper
7. Sliding Plate Damper

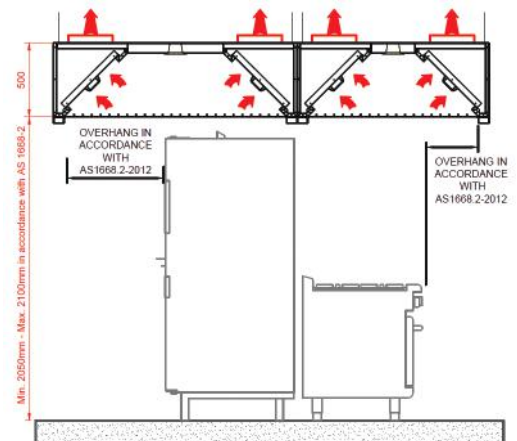
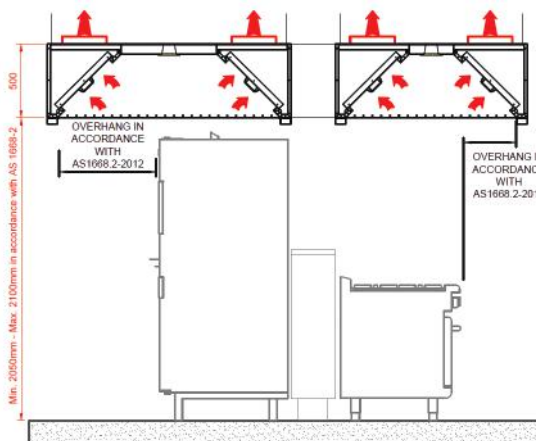
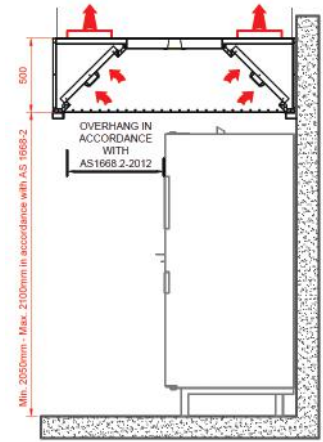
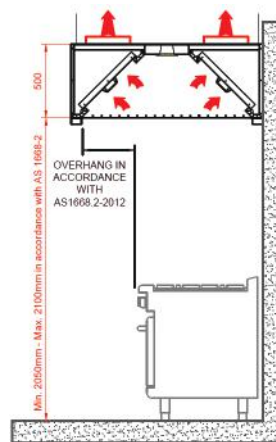





- Meets AS1668.2012 requirements
- Manufactured from T304 Stainless Steel
- Removes build up of condensation in dishwash areas, increasing wellbeing of staff
- Prevents damage to ceilings and walls
- Egg crate grille with spigot for connection by others

## Manufacturer Declaration of Conformity to AS1668.2 - 2012 Austream Kitchen Ventilation Systems

FSM is Australian owned and owns the registered name Austream; a low velocity commercial kitchen ventilation system. Austream is manufactured to the highest European specifications; The German standard VDI2052 and the British specification DW172. Austream is designed to DW172:2018 and meet the criteria of VDI2052:2017. These exhaust hoods are an engineered solution and as such have specific requirements to allow them to perform to their design and comply directly to BCA 2019 Volume 1, Amendment 1, Clause F4.12.

Austream low velocity hoods meet and exceed the requirements of AS1668.2-2012. Section 3 clause 3.4.1, the standard states '*Alternative exhaust hood designs including proprietary designs may be used provided that it can be established that the performance of such hoods is at least equivalent to the hoods described in this section.*' VDI2052:2017 and DW172:2018 are widely adopted and used throughout Australia and both exceed the requirements of the AS1668.2-2012 standard and this can be proven through existing installations in Australia.

## Add UV to your ventilation system.

UV has been used in Kitchen Exhaust hoods for many years and uses processes called photolysis and ozonolysis to break down grease. In photolysis the UV disassociates the bonds within the grease atoms. In ozonolysis, oxygen atoms (O<sub>2</sub>) are disassociated and these recombine into ozone (O<sub>3</sub>). The ozone then reacts with the grease and other organic compounds. The result from these processes is carbon dioxide (CO<sub>2</sub>), water (H<sub>2</sub>O), ozone, products such as peroxyacyl nitrates, and a small amount of white powder (sodium, calcium and organic compounds).

Our High Energy Ozone UV lamps are specifically designed for maximum output in high heat airflows. They are installed in the exhaust plenum inside the hood itself.

### UV Lamps:

- Produce ozone at the 185 nanometer wavelength which is very effective at removing greases, oils, cooking odours etc. from the airstream and on duct and fan surfaces in forced air extraction systems.
- By keeping the duct free of grease they reduce duct cleaning costs, fire hazards and fire prevention cost savings are achieved.
- We have the capability to engineer design the installation of the lamps to best suit the cooking equipment. Thus ensuring the best practice and most cost effective solution.
- Lamps are easily replaced at an 18-month period to ensure optimal performance.
- Effectively reduces odours and grease particles generated by cooking food
- Reduces and in some cases, eliminates the need for manual duct cleaning
- By keeping the extraction system free of grease, the risk of duct fire hazards are drastically reduced

In summary UV radiation can provide a simple environmentally friendly and economical method of breaking down grease and fat, keeping kitchen exhaust systems cleaner and reducing odours.



**FSM**

**AU**STREAM™

**MELBOURNE**  
(03) 9368 2300

**SYDNEY**  
(02) 9608 8620

**BRISBANE**  
(07) 3390 4185

**PERTH**  
0413 893 311

[sales@fsm-pl.com.au](mailto:sales@fsm-pl.com.au)  
[www.austream.com.au](http://www.austream.com.au)